

Omega 400

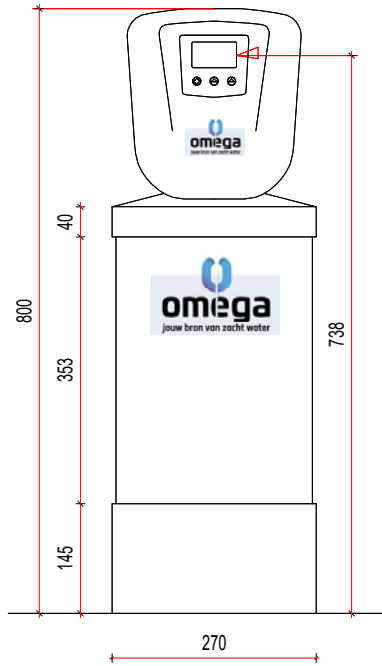

- A - 3/4 " buitendraad ingang
- B - 3/4 " buitendraad uitgang
- C - slang transparant naar vlotter zoutvat.
- D - push-fit aansluiting t.b.v. zwarte slang naar riool (min 40mm)
- E - trafo 230vac / 12vdc (kabel 200cm)
- F - overloop zoutvat
- G - gat voor transparante slang naar vlotter

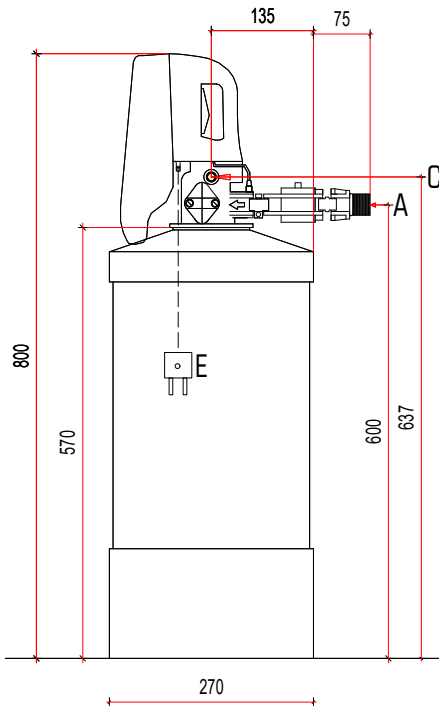